



• ACOUSTIC POD RANGE •





PEACE AND QUIET IN AN INSTANT

The Go Acoustic Pod range was designed to address two core issues relating to open plan environments. Firstly, the need for acoustic privacy and secondly, the need for internal rooms within the work space.

Each Pod is highly ergonomic and functional, packed with the latest technology when you need to stay connected.

SOLO



Single Person Pod

CONNECT



Dual Person Pod

ENGAGE



Meeting Pod

Peace in a pod...

GO pods are a compact soundproof workspace with huge benefits;

Equipped with lighting and a ventilation system which is activated by a movement sensor, all pods are fitted with USB, RJ45 Data plug and electrical sockets ensuring optimal power and connectivity.

• POD SERIES •

Energy Efficient



Sensor based on-off switch activates led lighting and ventilation fan helps to conserve energy.

High Acoustic Rating



Beautifully designed using selected materials for absorption and isolation performance with Acoustic Test Certificates.

Easy to Assemble



Flat packed for ease of delivery and installation.

Retractable & Portable

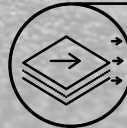

Fitted with integrated ball bearings, allowing pods to be easily repositioned into desired locations after assembly.

Highest Quality



Sophisticated automation machinery ensures consistency of quality, while robust construction and premium materials create a product of the finest quality.

Comfortable & Breathable



Work comfortably in a well-ventilated space with great acoustic properties.



SOLO

Single Person Pod.

The SOLO Pod is designed to fit one person and is suitable for phone-calls and concentration.

An ideal space to work in silence with optimum acoustic shielding from the surrounding work environment.

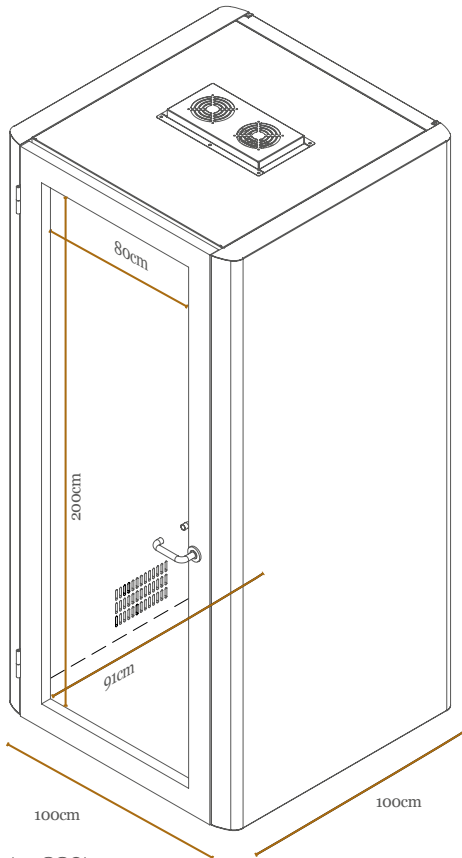
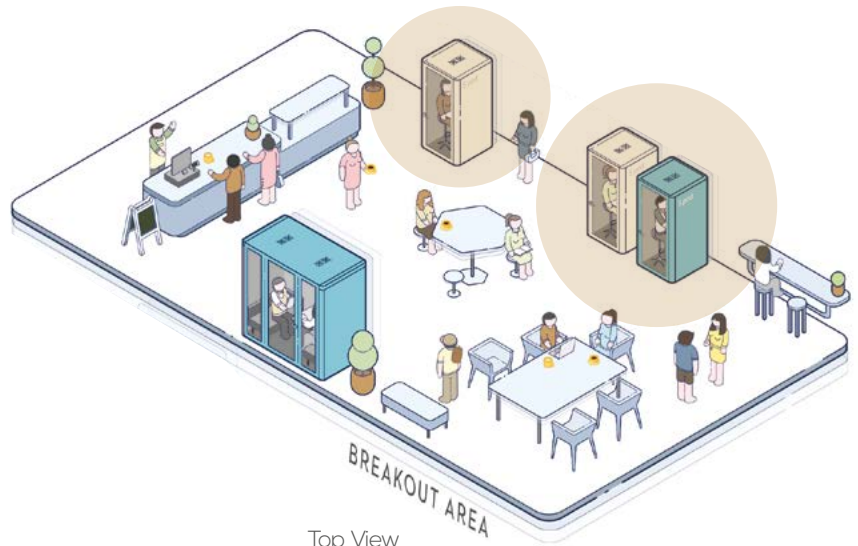

Gross weight: 320kg

Top View

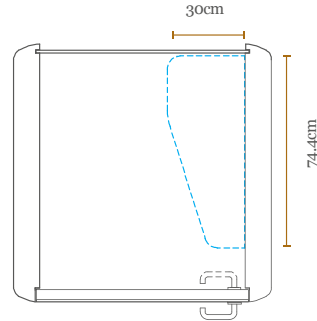

Front View

Rear View

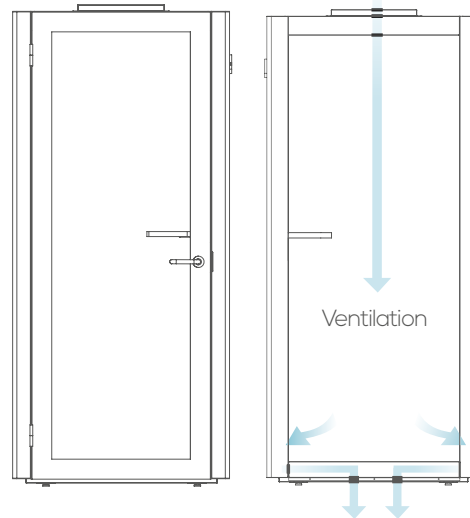

Acoustic test certificates



HIGH
ACOUSTIC
RATING
TUV - 32 dB / NIC
CERTIFIED BY TUV



VOC AND
FORMALDEHYDE-
FREE
RATING
0.005 MG/M3
CERTIFIED BY SGS

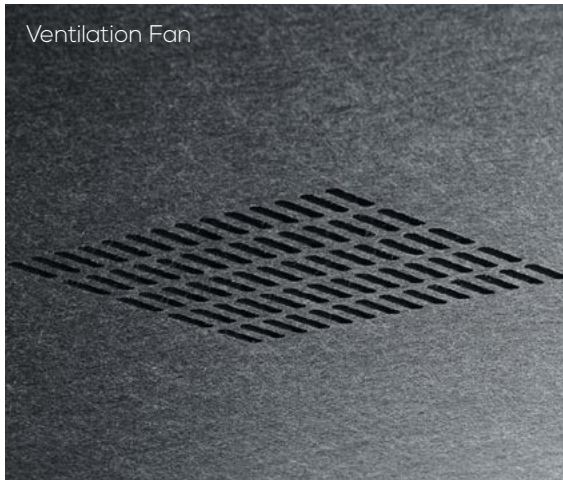

SOLO

Single Person Booth.



Stool Not Included

Fitted with a work top, power supply and computer connections, the SOLO Pod is a perfectly silent working space.





CONNECT

Dual Person Pod.

The CONNECT Pod provides a feeling of privacy and is perfect for holding small meetings, brainstorming sessions and one to one conversations without the disturbance of an open space.

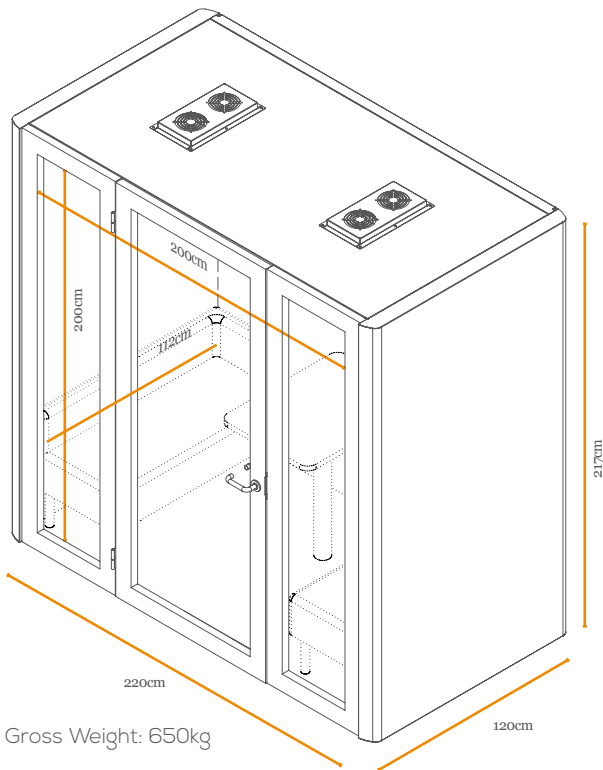
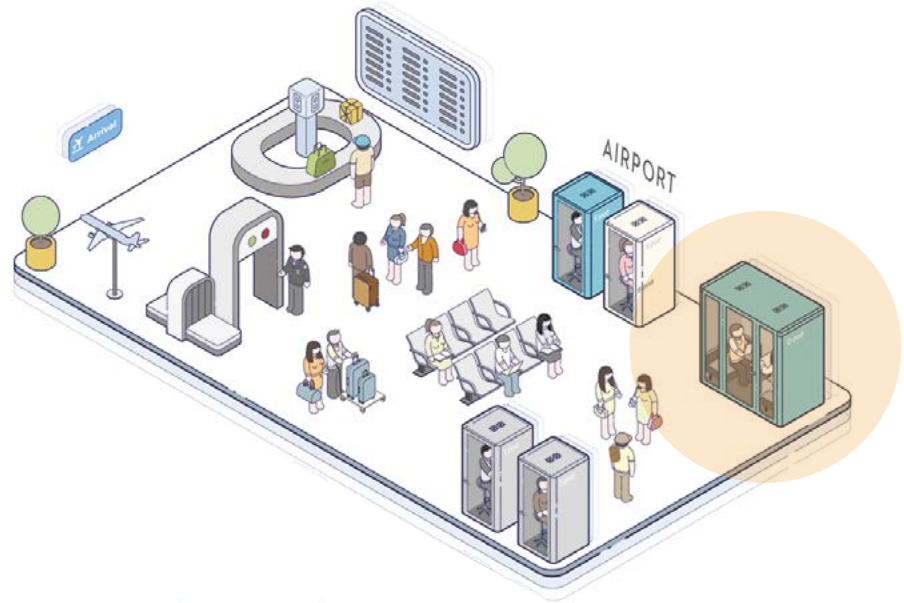

Gross Weight: 650kg

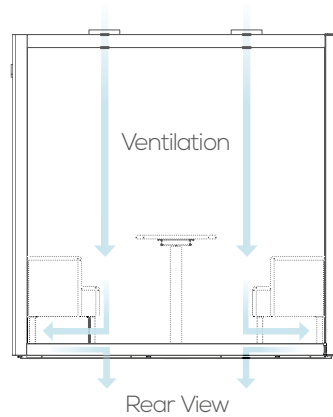

Rear View

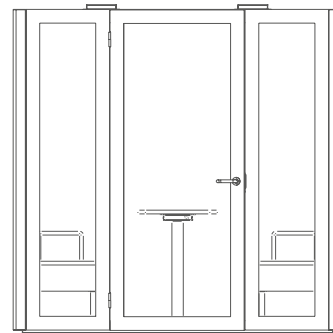

Front View

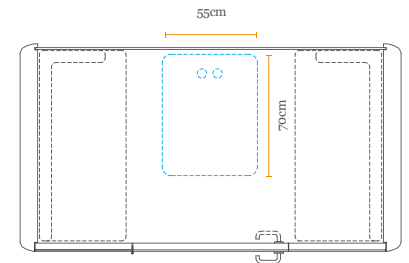

Top View

Acoustic test certificates



PSB Singapore

Add value.
Inspire trust.

**HIGH
ACOUSTIC
RATING**
TUV - 32 dB / NIC
CERTIFIED BY TUV

**VOC AND
FORMALDEHYDE-
FREE
RATING**
0.005 MG/M3
CERTIFIED BY SGS

Ventilation Fan

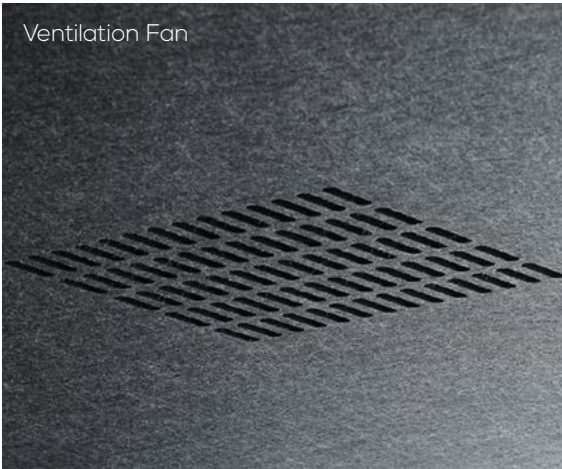

LED strip light



AH Meyer Power, RJ45 data point & USB charging fitted to table top

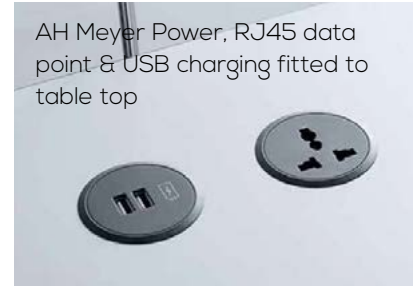

Laminated Glass & Dorma Locksets



Wireless Dimmer



Steel Carcass



Motion Sensor



Laminated Table & 2 bench seats



CONNECT

Dual Person Pod.

The CONNECT Pod is fitted with a working table, upholstered bench seating, power outlets and computer connections and will seat two to four people comfortably. Ideal for phone calls, video conferences and meetings all in a soundproof working space.





ENGAGE

Meeting Pod.

Due to the size of the ENGAGE Pod, it is a perfect independent office space for group meetings and will fit six+ people comfortably. An excellent alternative to a small conference room.

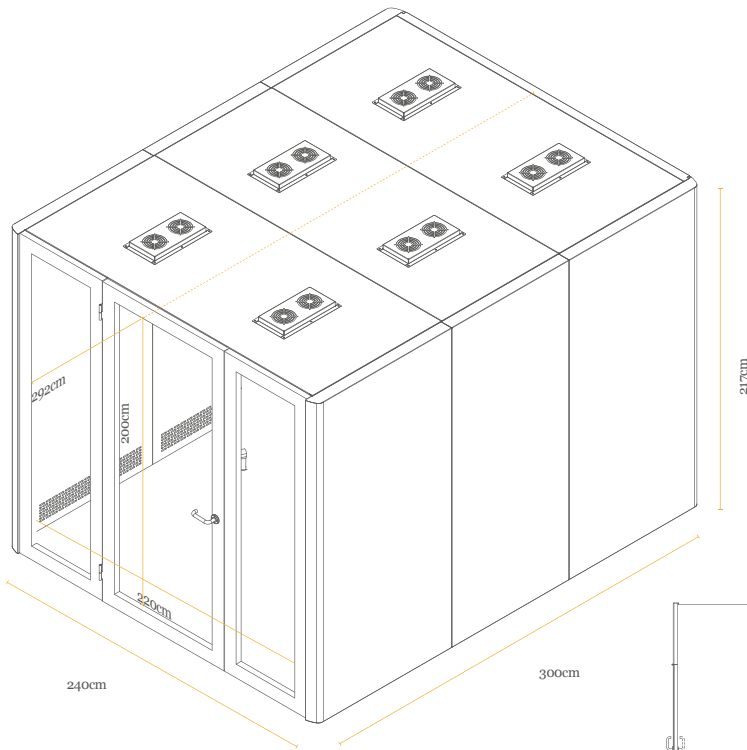
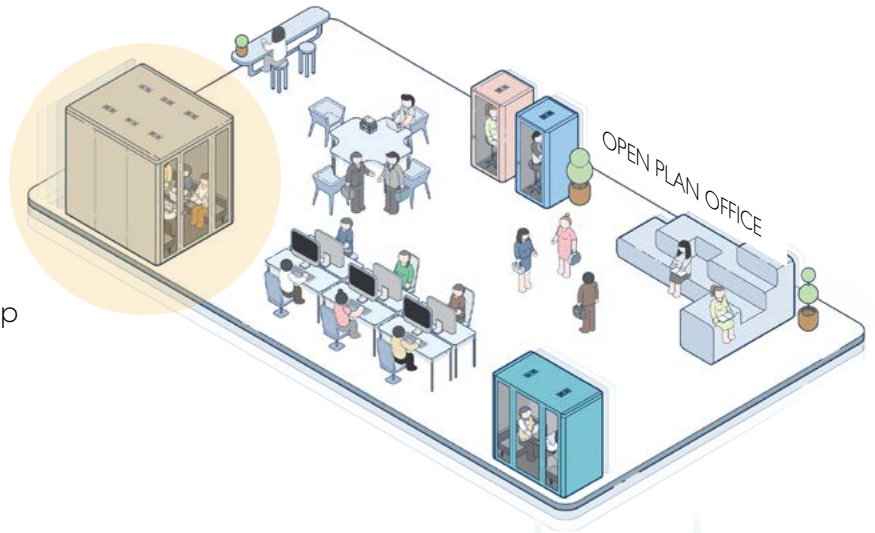

Gross Weight: 1300kg

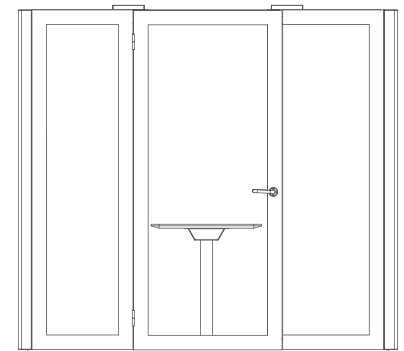
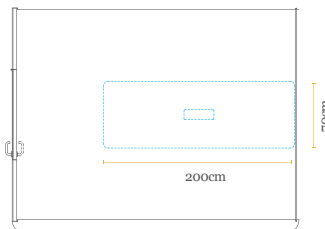
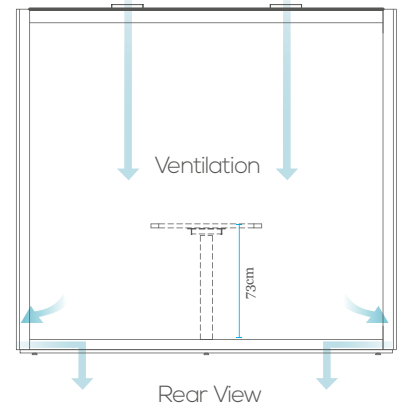

Top View

Front View

Acoustic test certificates



PSB Singapore

Add value.
Inspire trust.

**HIGH
ACOUSTIC
RATING**
TUV - 32 dB / NIC
CERTIFIED BY TUV



**VOC AND
FORMALDEHYDE-
FREE
RATING**
0.005 MG/M3
CERTIFIED BY SGS

Ventilation Fans

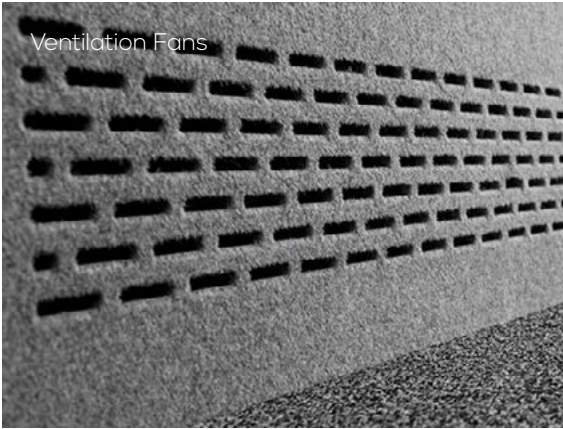

LED strip lights



AH Meyer Power, RJ45
data point & USB
charging fitted to
table top

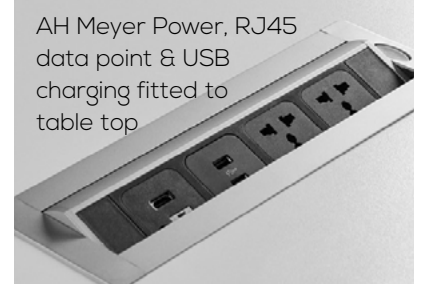

Laminated Glass &
Dorma Locksets



Wireless Dimmer



Tempered Glass Whiteboard
(optional extra)



Motion Sensor



Working Table



ENGAGE

Meeting Pod.

Fitted with a 2m table, the ENGAGE Pod is large enough to be converted into a breakout area (when the table is removed) and furnished with soft seating, coffee tables and plants, creating a comfortable working environment.



Seats not included



Privacy Anytime, Anywhere.

When you need to work with maximum focus and minimal distraction, Go Acoustic Pods are ideal for uninterrupted work, holding discussions, making important calls and teleconferences.

DESIGNED TO FIT:

OPEN PLAN OFFICES
RECEPTION HALLS
EXHIBITION CENTRES
BREAKOUT AREAS
CAFETERIAS
AIRPORTS
LIBRARIES
FACTORY FLOORS
SHOPPING MALLS
EDUCATIONAL FACILITIES



Single Person Pod



Dual Person Pod



Meeting Pod

Stocked Colours.

OTHER COLOUR OPTIONS ARE AVAILABLE SUBJECT TO LEAD TIMES

CARCASS



WHITE

CHAIR FABRIC

CONNECT POD ONLY



BLACK

ACOUSTIC WALLS



CHARCOAL BLACK

CARPET



BLACK

